



Assembly and Operating Instructions for Outback® Omega 150, and Omega 250 Gas Barbecues



Omega 150



Omega 250

Photographs are not to scale.
Specifications subject to change
without prior notice.



CE 0359



WARNING

- For outdoor use only.
- Read instructions before using the appliance. Failure to follow instructions could result in death, serious bodily injury, and/or property loss.
- Warning: accessible parts may be very hot. Keep young children away.
- Do not move the appliance during use.
- Turn off the gas supply at the gas bottle after use.
- Any modification of the appliance, misuse, or failure to follow the instructions may be dangerous and will invalidate your warranty. This does not affect your statutory rights.
- Retain these instructions for future reference.
- Leak test your barbecue annually. Check the hose connections are tight and leak test each time you reconnect the gas bottle.

FOR YOUR SAFETY

If you smell gas:

1. Shut off gas to the appliance.
2. Extinguish any open flame.
3. Open barbecue lid or hood.
4. If odour continues, discontinue use and contact your local dealer.

FOR YOUR SAFETY

1. Do not store or use petrol or other flammable vapours or liquids in the vicinity of this or any other appliance.
2. A gas bottle not connected for use shall not be stored in the vicinity of this or any other appliance.

A. Parts List

Quantities vary according to model purchased. Specifications subject to change without prior notice. For more details on hardware, please see the corresponding Hardware Reference Diagram for your barbecue model.

		OUTBACK® OMEGA RANGE			
	CODE	PART	QTY	OMEGA 150	OMEGA 250
Body Assembly	A1	Lava Rock / Basket	1	✓*	✓*
	A2	Burner	1	✓*	✓*
	A3	Hood Handle	1	✓	✓
	A4	Hood	1	✓*	✓*
	A5	Body	1	✓*	✓*
	A6	Grease Cup Holder	1	✓*	✓*
	A7	Grease Cup	1	✓	✓
	A8	Cooking Grill	1	✓*	✓*▲
	A9	Gasket	8	✓*	✓*
	A10	Upper Hinge Bracket	2	✓*	✓*
	A11	Lower Hinge Bracket	2	✓*	✓*
	A12	Gas Collector Box	1	✓*	✓*
	A13	Main Electrode	1	✓*	✓*
Upper Trolley	B1	Control Panel	1	✓*	✓*
	B2	Igniter Button	1	✓*	✓*
	B3	Knob	2	✓*	✓*
	B4	Body Handle			
	B5	U-Bar	2	✓*	✓*
	B6	Hose	1	✓*	✓*
	B7	Plastic Side Shelf	1	✓	✓
	B8	Side Burner Knob	1		✓*
	B9	Side Burner Grid	1		✓
	B10	Side Burner Shelf	1		✓
	B11	Side Burner Head	1		✓*
	B12	Side Burner Electrode	1		✓*
Lower Trolley	C1	Short Leg	2	✓	✓
	C2	Short Axle	2	✓	✓
	C3	Wheel	2	✓	✓
	C4	Hubcap	2	✓	✓
	C5	Screen	1	✓	✓
	C6	Long Support Rod	2	✓	
	C7	Stopper	2	✓*	✓*
	C8	Long Leg	2	✓	✓
	C9	Short Support Rod	2	✓	
	C10	Bottom Shelf	1		✓
Hardware	D1	ST4.0x10 Screw	2	✓*	✓*
	D2	M5x10 Bolt	2	✓	✓
	D3	M6x25 Bolt	4	✓	✓
	D4	M6x30 Bolt	4	✓	✓
	D5	M6x40 Bolt	▲	4	8
	D6	M6x50 Bolt	4	✓	✓
	D7	Axle Clip	2	✓	✓
	D8	M6 Keps Nut	▲	8	20
	D9	Shelf Spacer	▲	4	8
	D10	Shelf Washer	▲	4	8

* Pre-Assembled

▲ Quantity and specification varies according to model purchased.

B1. Parts Diagram: Omega 150

Quantities vary according to model purchased. Specifications subject to change without prior notice. For more details on hardware, please see 'Hardware Reference Diagram: Omega 150.'



B2. Hardware Reference Diagram: Omega 150

Specifications subject to change without prior notice.

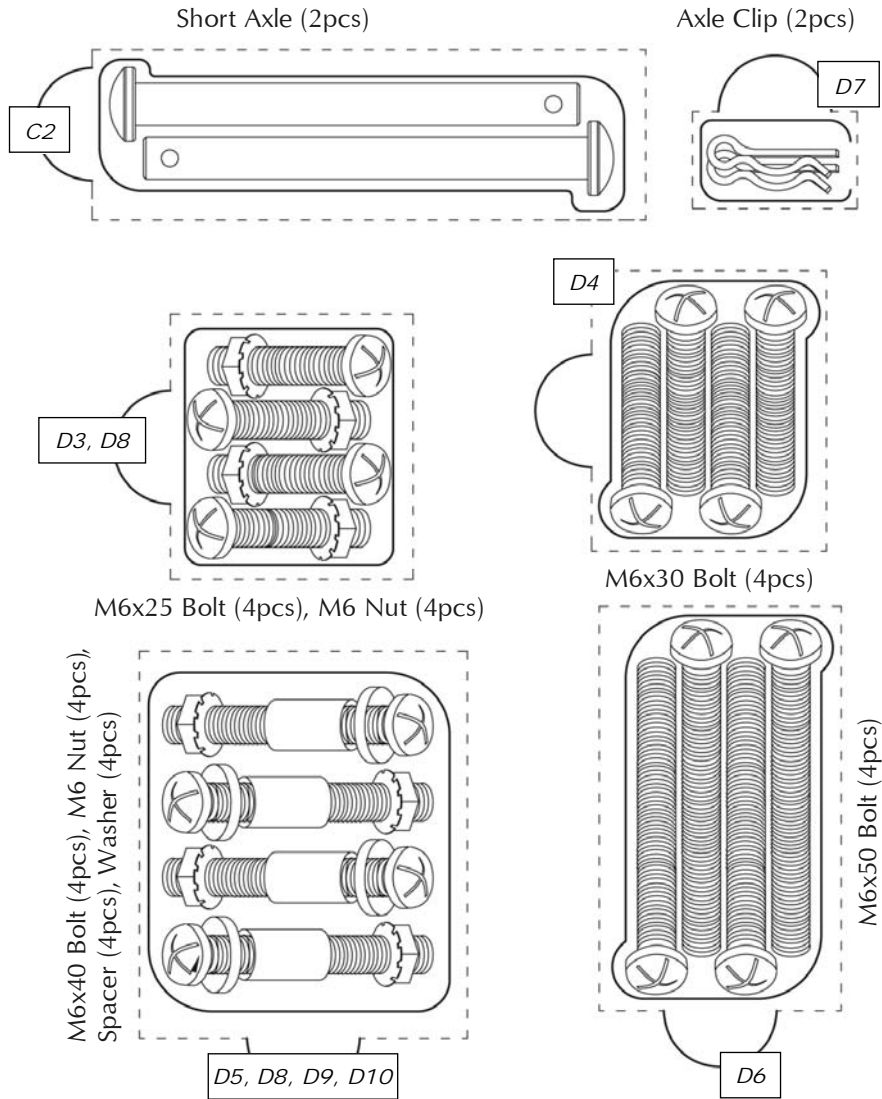

C1. Parts Diagram: Omega 250

Quantities vary according to model purchased. Specifications subject to change without prior notice. For more details on hardware, please see 'Hardware Reference Diagram: Omega 250.'

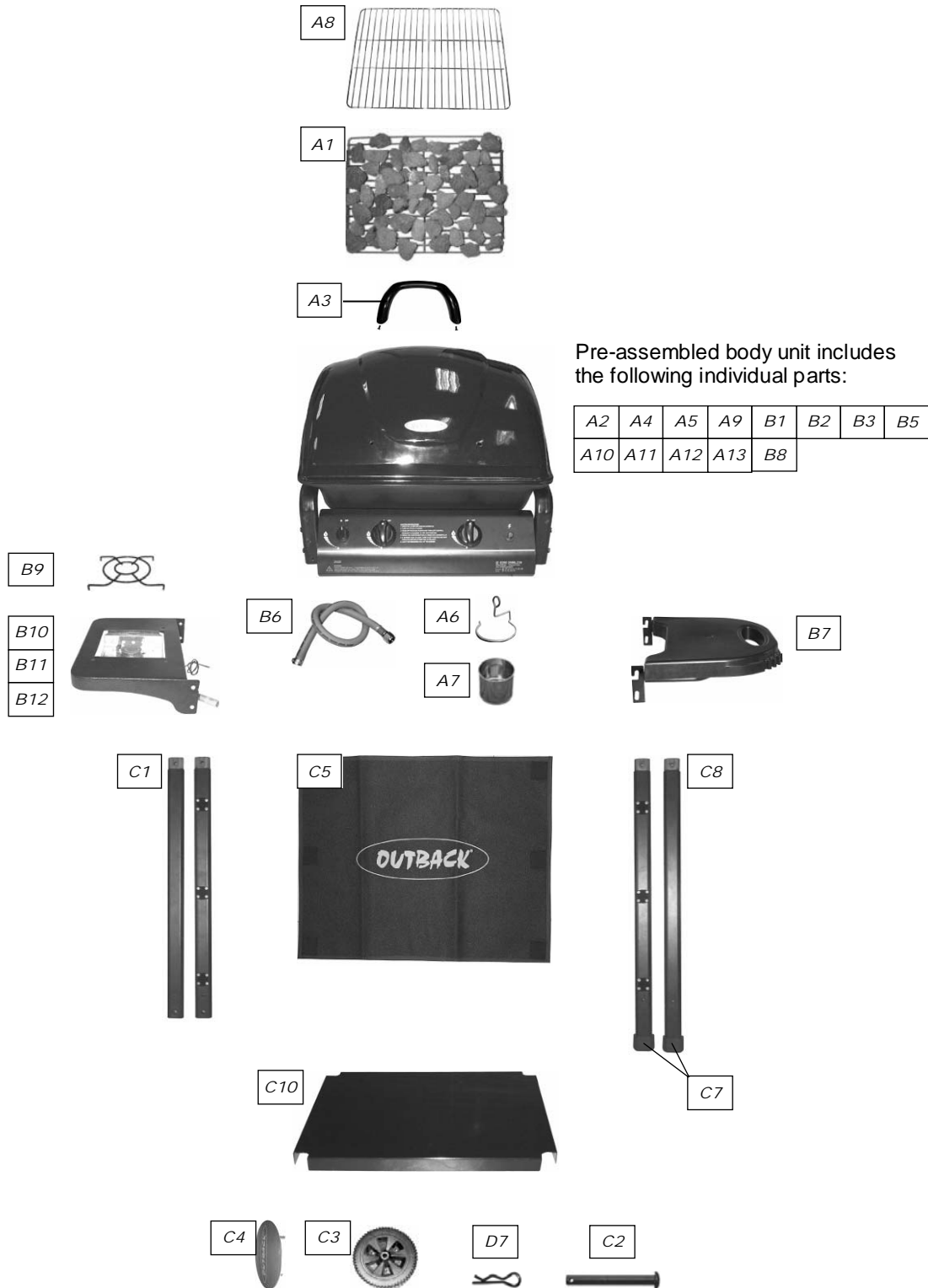

C2. Hardware Reference Diagram: Omega 250

Specifications subject to change without prior notice.

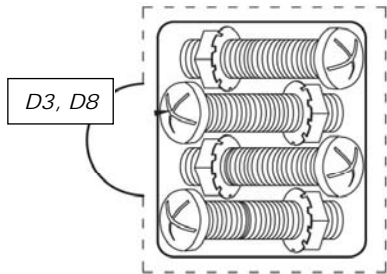
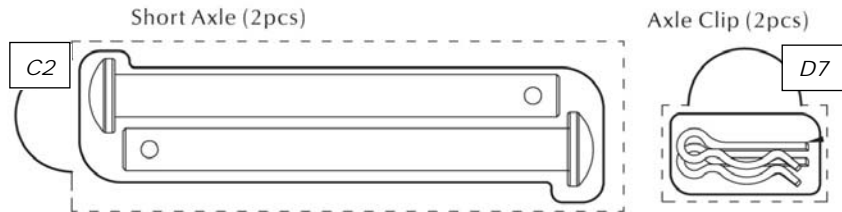

M6x25 Bolt (4pcs), M6 Nut (4pcs)

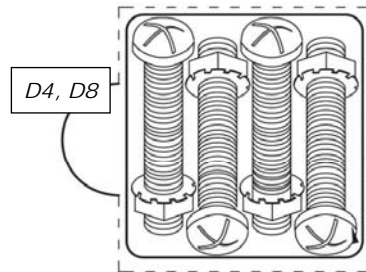

M6x30 Bolt (4pcs), M6 Nut (4pcs)

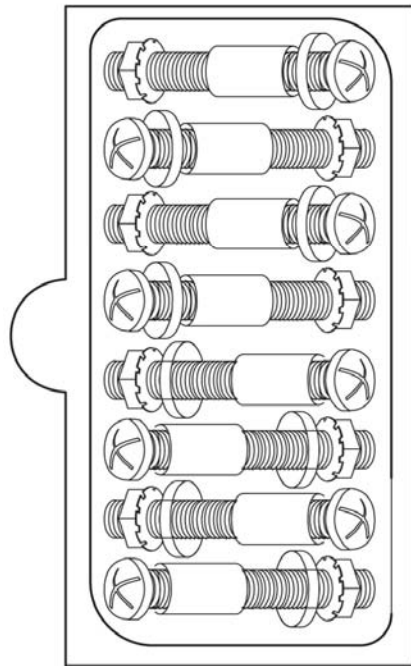

M6x40 Bolt (8pcs), M6 Nut (8pcs), Spacer (8pcs), Washer (8pcs)

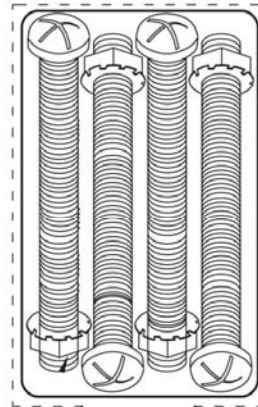

M6x50 Bolt (4pcs), M6 Nut (4pcs)

D. Assembly

TOOLS NEEDED FOR ASSEMBLY:

Medium size flat blade or Philips/crosspoint screwdriver, adjustable spanner or metric spanner set
Please lay out all nuts and bolts and check lengths before assembling.

1

✓ Omega 150

✓ Omega 250

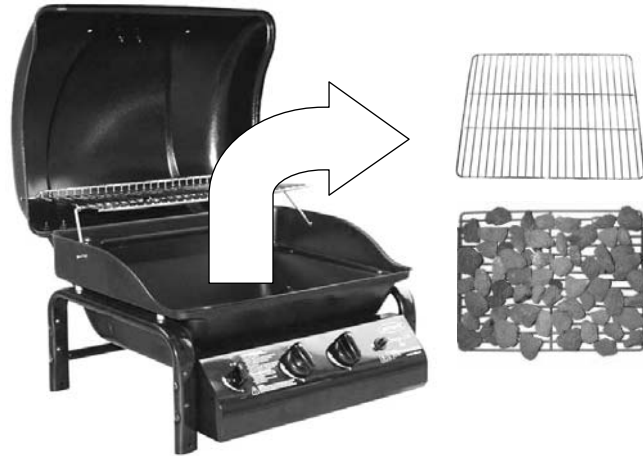

2

✓ Omega 150

✓ Omega 250

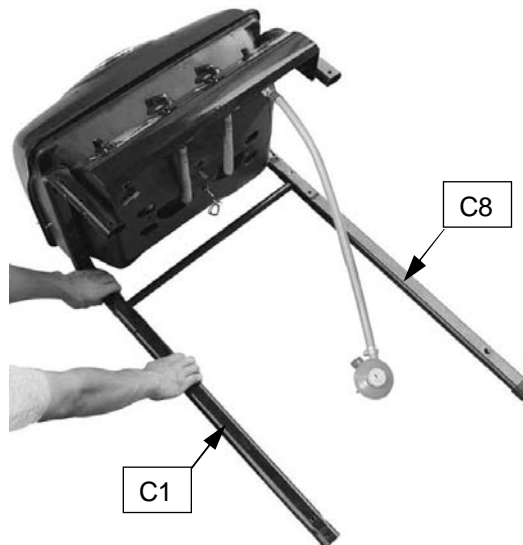

Warning: Care must be taken to ensure hood does not fall open unexpectedly.

3

✓ Omega 150

✓ Omega 250

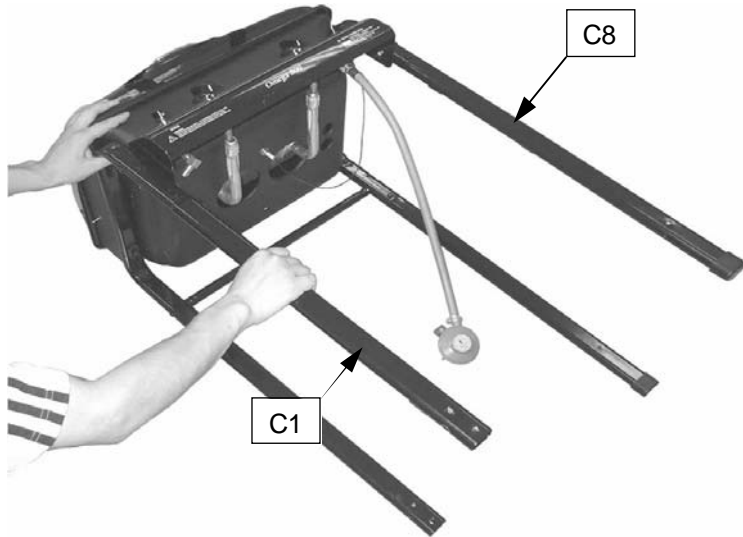

NOTE: Ensure that the legs with the Velcro attached to them are at the front of the barbecue, with the Velcro facing inwards.

4

✓ Omega 150

✓ Omega 250

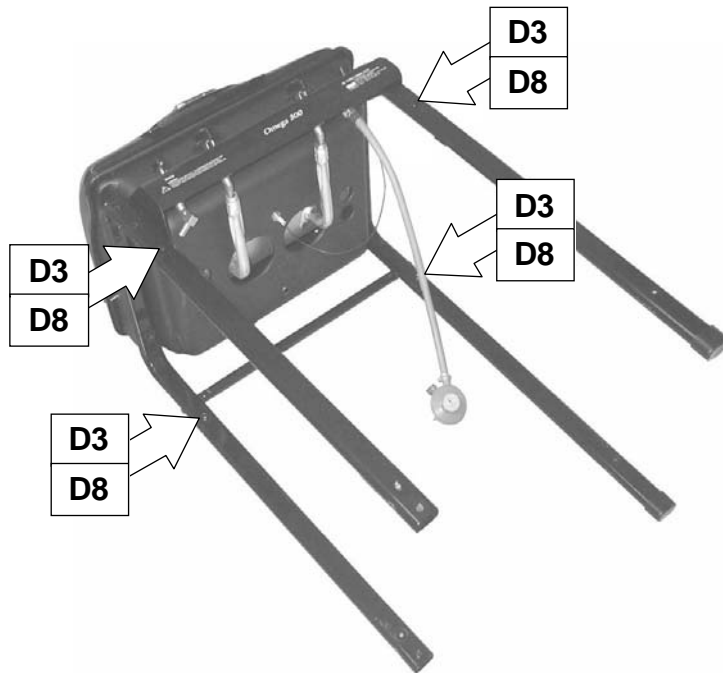

5

✓ Omega 150

✗ Omega 250

▲ Omega 250 users skip this step and proceed directly to Step 7.

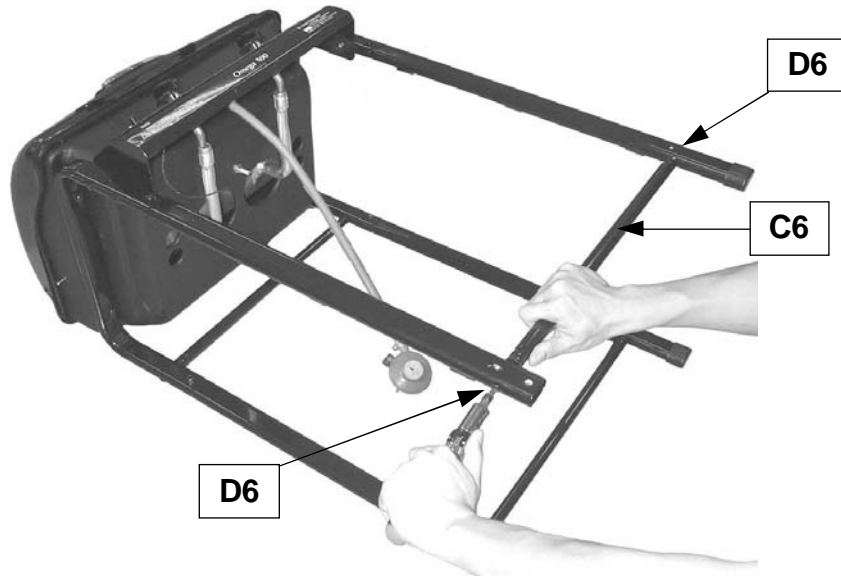

6

✓ Omega 150

✗ Omega 250

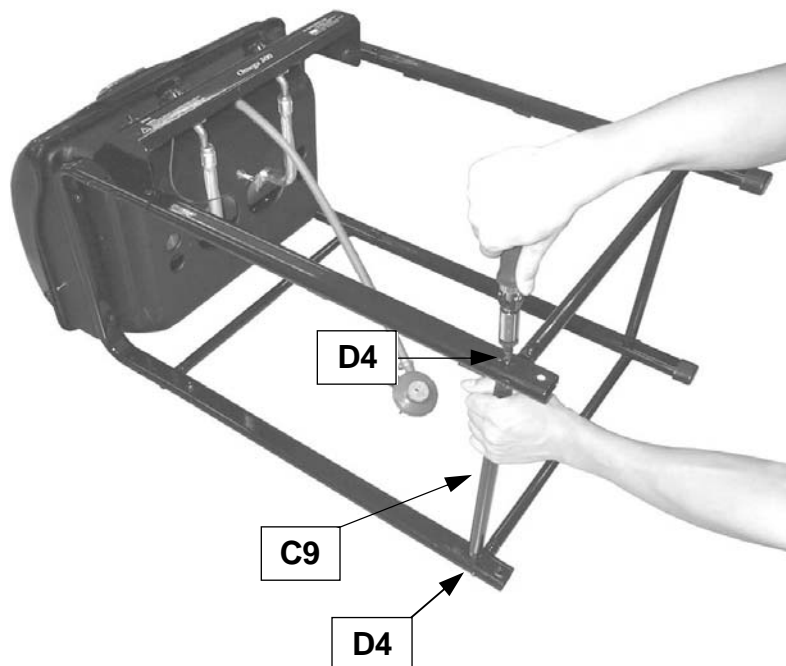

7

✘ Omega 150

✔ Omega 250

▲ Omega 150 users skip this step and proceed directly to Step 8.

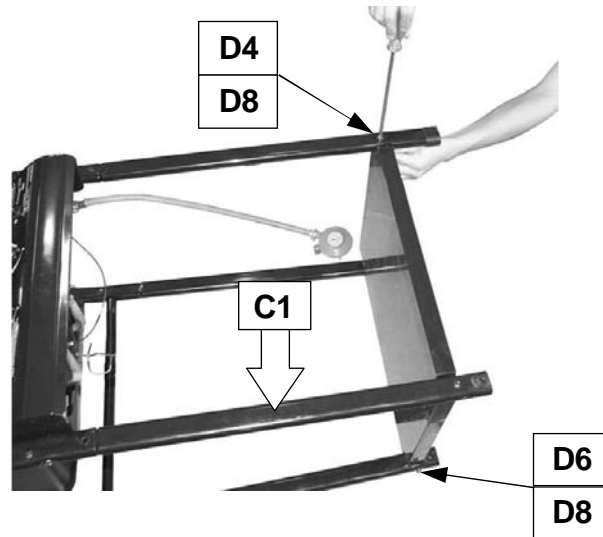

8

✔ Omega 150

✔ Omega 250

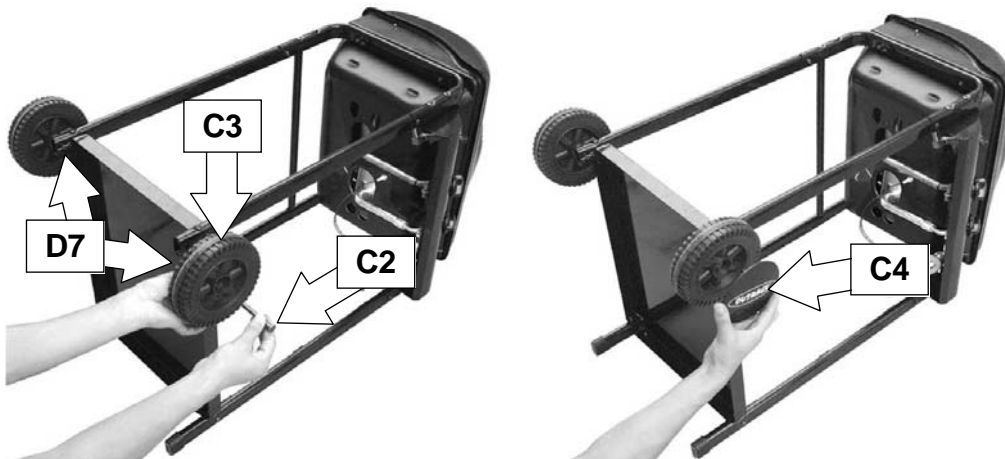

9

✓ Omega 150

✓ Omega 250

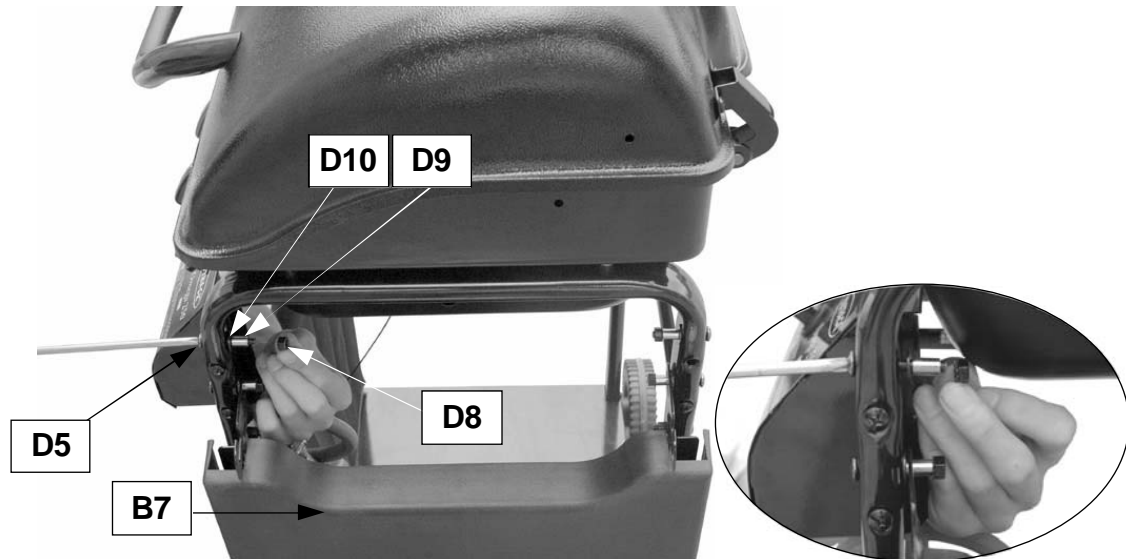

Note: The spacers and side shelf brackets go on the inside of the barbecue frame.

10

✗ Omega 150

✓ Omega 250

▲ Omega 150 users skip this step and proceed directly to Step 12.

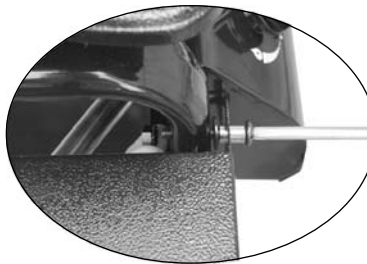
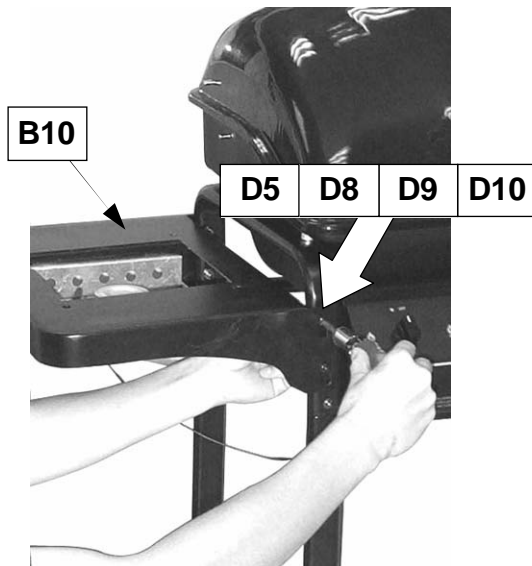

▲ Fit the side burner venturi tube over the gas valve outlet. This is a loose fit and not a gas tight seal. Then attach side burner shelf as shown in the diagram.

▲ Connect the side burner electrode wire to the tag on the side of the push button igniter.

11

✗ Omega 150

✓ Omega 250

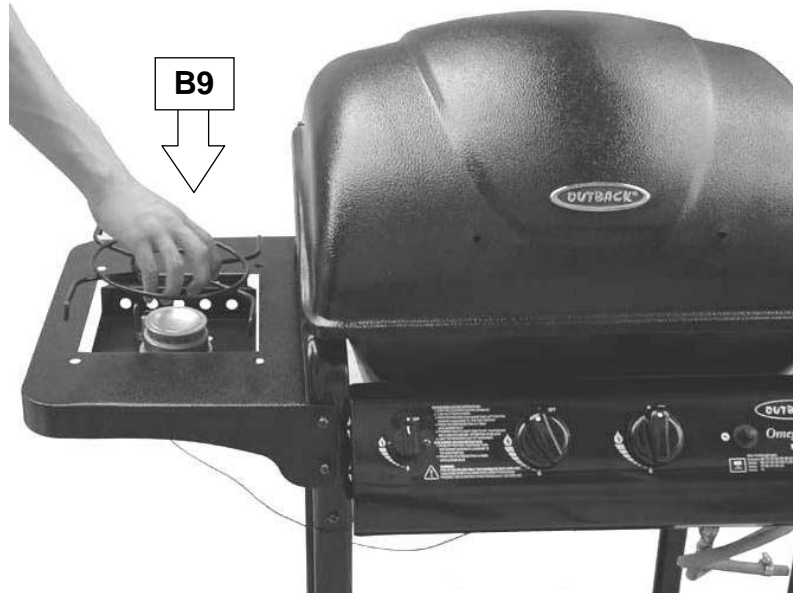

12

✓ Omega 150

✓ Omega 250

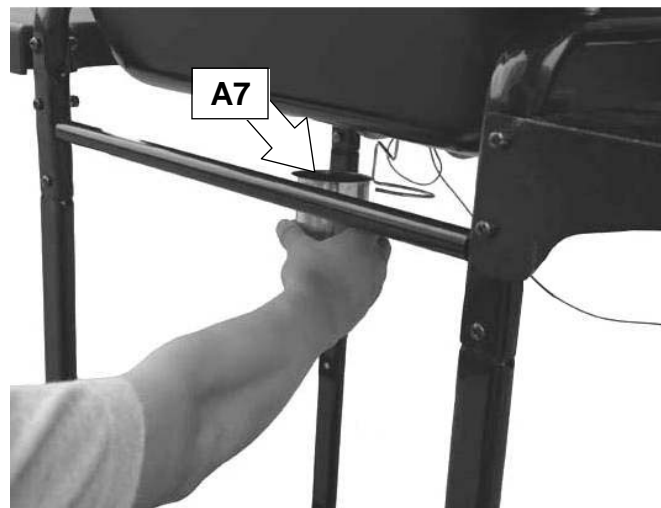

▲ Insert grease cup into wire cup holder.

13

✓ Omega 150

✓ Omega 250



14

✓ Omega 150

✓ Omega 250

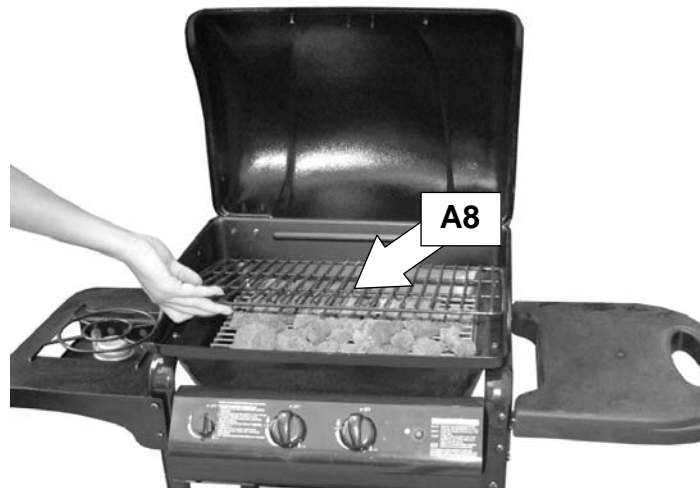

15

✓ Omega 150

✓ Omega 250

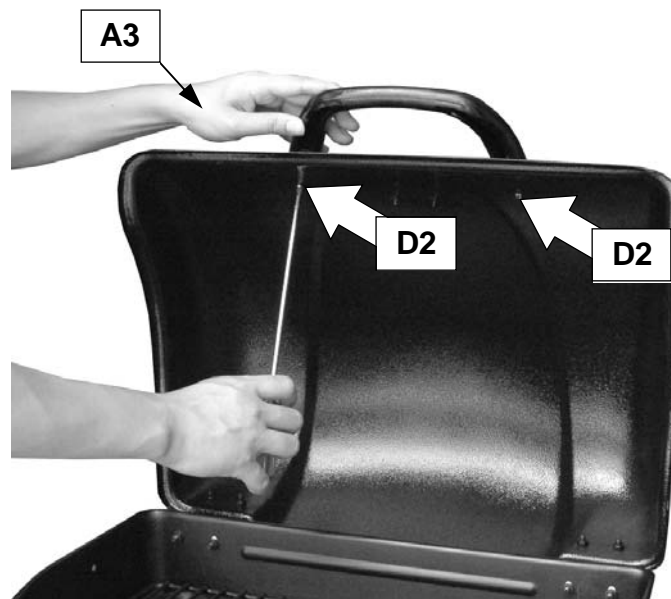

16

✓ Omega 150

✓ Omega 250

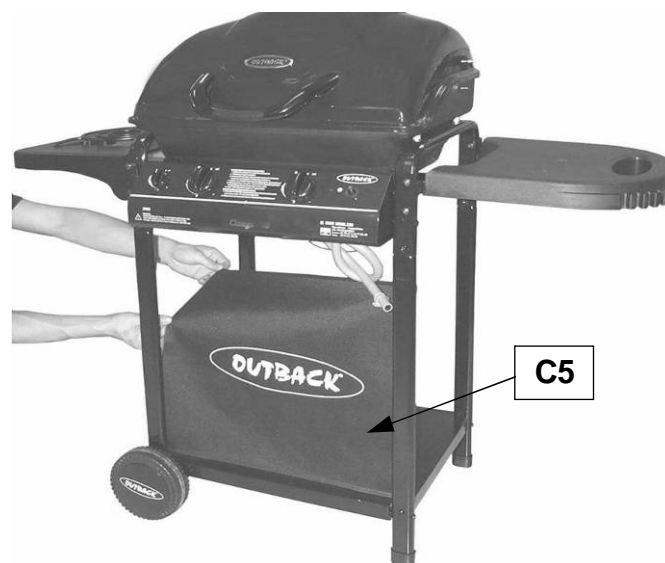

ASSEMBLY IS NOW COMPLETE.

**PROCEED TO THE NEXT PAGE FOR INSTRUCTIONS ON
OPERATION AND MAINTENANCE.**

REFER TO THE LEAK TEST INSTRUCTIONS ON PAGE 16.

E. Important Information

Please read these instructions carefully before assembly and use.

- Retain these instructions for future reference.
- For outdoors use only – do not use indoors. Do not use below ground level.
- For use with LPG bottled gas only. A fixed pressure regulator of 28-30mbar must be used for butane or 37mbar for propane. The use of an adjustable regulator is dangerous and must never be used with this barbecue.
- Remove lava rock from plastic bag before lighting.
- Do not use within 1m of any flammable structure or surface.
- LP gas cylinders should not be placed directly underneath the barbecue.
- LP gas cylinders must not be stored or used in the horizontal position. A leak would be very serious and liquid could enter the gas line.
- When igniting barbecue open its hood before lighting.
- Do not move the barbecue while alight.
- This barbecue must not be left unattended when lit.
- The hood handle can become very hot. Grip only the centre of the handle. Use of a cooking glove is advised.
- Use caution when opening the hood, as hot steam inside is released upon opening.
- Parts of this barbecue become very hot – care must be taken when children, elderly people, and animals are present.
- Always turn off the gas bottle when the barbecue is not in use.
- Never cover a barbecue until it has completely cooled.
- Leak test the barbecue annually. Check that the hose connection to the barbecue is tight and leak test whenever the gas bottle is reconnected.
- Do not store flammable materials near this barbecue.
- Do not use aerosols near this barbecue.
- Failure to follow the manual's instructions could result in serious injury or damage.
- If you have any queries regarding these instructions, contact your local dealer.

F. Gas and Regulator

This barbecue, hose, (and regulator, if included), are approved for use in the UK. The barbecue is also approved for use in other countries as listed on the control panel and in the Technical Specifications included in the barbecue manual. If the barbecue is intended to be used outside of the UK, the consumer **MUST** seek advice from the local qualified gas supplier as to the suitability of the barbecue and with regards to the correct hose and regulator that they should be using.

This barbecue can run on butane or propane LPG (liquid petroleum gas) bottled gas. Butane gas is normally supplied in blue bottles. Propane gas is supplied under a number of different names and bottle colours. Butane gas is suitable for your barbecue in normal use but you may notice a decrease in performance when the gas temperature starts to fall below +10 degrees Celsius. If this happens we recommend propane gas is used. If in doubt, please consult your gas dealer/distributor. The gas bottle should never be stood on the trolley base or placed directly under the barbecue. Do not use or store a gas bottle on its side.

For optimal performance, we suggest the following:

Model	Butane Minimum Bottle Size	Propane Minimum Bottle Size
Outback® Omega150	6kg	3.9kg
Outback® Omega 250	15kg	6kg

Suitable regulators for butane must have an outlet pressure of 28-30mbar. For propane, the regulator must have an outlet pressure of 37mbar. **YOU MUST HAVE THE PROPER REGULATOR AND BOTTLE IN ORDER FOR THE BARBECUE TO OPERATE SAFELY AND EFFICIENTLY. USE OF AN INCORRECT OR FAULTY REGULATOR IS DANGEROUS AND WILL INVALIDATE ANY WARRANTY.** If in doubt, please consult your gas dealer/distributor.

G. Installation

H1. Selecting a Location

This barbecue is for outdoor use only and should be placed in a well-ventilated area. Take care to ensure that it is not placed **UNDER** any combustible surface. The sides of the barbecue should **NEVER** be closer than 1 metre from any combustible surface. Keep this barbecue away from any flammable materials!

G2. Precautions

Do not obstruct any ventilation openings in the barbecue body. Position the gas supply bottle on level ground next to the barbecue and safely away from any source of heat. Should you need to change the gas bottle, confirm that the barbecue is switched off, and that there are no sources of ignition (cigarettes, open flame, sparks, etc.) near before proceeding. Inspect the hose for damage and ensure it is securely attached with worm drive clips or swaged fittings. Ensure no part of the flexible hose is touching any hot barbecue parts. If the hose is damaged, it must be replaced with hose suitable for use with LPG and meet the national standards for the country of use. The length of hose shall not exceed 1.5m. *N.B. – The date on UK hose is the date of manufacture, not the expiry date.*

G3. Fixing a Regulator to the Gas Bottle

Confirm all barbecue control knobs are in the off position. Connect the regulator to the gas bottle according to your regulator and bottle dealer's instructions.

G4. Leak Testing (To be performed in a well-ventilated area.)

Confirm all control knobs are in the off position. Open the gas control valve on the bottle or regulator. Check for leaks by brushing a solution of ½ water and ½ soap over all gas system joints, including all valve connections, hose connections and regulator connections. NEVER USE AN OPEN FLAME to test for leaks at anytime. If bubbles form over any of the joints, there is a leak. Turn off the gas supply and retighten all joints. Repeat test. If bubbles form again, do not use the barbecue. Please contact your local dealer for assistance. Leak test annually. Check that the hose connection to the barbecue is tight and leak test whenever the gas bottle is reconnected.

H. Operation

H1. Warning

- Before proceeding, make certain that you understand the ***IMPORTANT INFORMATION*** section of this manual.

H2. Preparation Before Cooking

To prevent foods from sticking to the cooking grill, please use a long handled brush to apply a light coat of cooking or vegetable oil before each barbecuing session. **(Note: When cooking for the first time, paint colours may change slightly as a result. This is normal and should be expected.)**

H3. Lighting the Barbecue

- Open the barbecue hood.
- Ensure all knobs are in the off position. Open the gas control valve on the gas bottle or regulator.
- Push and turn the leftmost control knob to the high position. Press the ignition button rapidly several times until left portion of the burner is lit. If burner fails to ignite, turn control knob to the off position and turn gas off at the bottle or regulator. Wait five minutes, then repeat the above steps. After successful lighting of the left side, ignite the remaining portion of the burner. If the burner fails to ignite after following above procedure, turn all the knobs to the off position. Close the gas valve on the gas bottle. Wait 5 minutes, then repeat the above steps. If the barbecue still fails to light, please refer to the manual ignition instructions in section below.
- After ignition, the burner should be burned at the high position for 3-5 minutes in order to preheat the barbecue. This process should be done before every cooking session. The hood (where applicable) should be open during preheating.
- After preheating, the burner should normally be turned down to a lower setting for best cooking results.

H4. Manual Ignition Instructions

- Insert lit match through the match-lighting hole on the right side of the barbecue.
- Push and turn the rightmost control knob anti-clockwise to the high position.
- After the right portion of the burner is lit, light the remaining portion of the burner.
- If burner fails to ignite, contact your local dealer for assistance.
- After ignition, the burner should be burned at the high position for 3-5 minutes in order to preheat the barbecue. This process should be done before every cooking session. The hood (where applicable) should be open during preheating.
- After preheating, the burner should normally be turned down to a lower setting for best cooking results.

H5. Grill Cooking

The burner heats up the lava rock underneath the grill, which in turn heats the food on the grill. The natural food juices produced during cooking fall onto the hot lava rock below and vaporise. The subsequent rising smoke bastes the food, as it travels upwards, imparting that unique barbecued flavour. More even cooking of food will be achieved by using the BBQ with the hood down. This should only be done with the burners on low.

When using your barbecue for grill cooking you may wish to place the hood in the closed position which will hold the heat in to aid cooking.

H6. Roasting Hood Cooking

Barbecues equipped with a roasting hood give the option of cooking with hood closed to form an 'oven' for roasting food, such as joints of meat, whole chickens, etc.

When roasting, turn the burner under the food to the OFF position. Close the hood and turn the other burner down to a lower setting i.e. low to medium to achieve the temperature required. **DO NOT ALLOW YOUR BARBECUE TO OVERHEAT.** Avoid lifting the hood unnecessarily as heat is lost each time the hood is opened.

H7. Flare-Up Control

Flare-ups occur when meat is barbecued, and its fat and juices fall upon the hot lava rock. Smoke helps give food its barbecued flavour, but avoid excessive flare-up to prevent food being burned. To control flare-up, it is advisable to trim away excess fat from meat and poultry before grilling. To reduce flare ups, the burner should be turned down to the low setting. Flare-ups can be extinguished by applying baking soda or salt directly onto the lava rocks. Always protect your hands when handling anything near the cooking surface of the barbecue.

H8. End of Cooking Session

After each cooking session, turn the barbecue burner to the "high" position and burn for 5 minutes. This procedure will burn off cooking residue, thus making cleaning easier. Make sure the hood is open during this process.

H9. Turning Off Your Barbecue

When you have finished using your barbecue, turn all the control valves fully clockwise to the "Off" position, then switch off the gas at the bottle. Wait until the barbecue is sufficiently cool before closing its hood.

I. CARE AND MAINTENANCE

Regularly clean your barbecue between uses and especially after extended periods of storage. Ensure the barbecue and its components are sufficiently cool before cleaning. Do not leave the barbecue exposed to outside weather conditions or stored in damp, moist areas.

- Never douse the barbecue with water when its surfaces are hot.
- Never handle hot parts with unprotected hands.

In order to extend the life and maintain the condition of your barbecue, we strongly recommend that the unit be covered when left outside for any length of time, especially during the winter months. Heavy-duty Outback® barbecue covers and other accessories are available from your local Outback® stockist.

Even when your barbecue is covered for its protection, it must be inspected on a regular basis as damp or condensation can form which may result in damage to the barbecue. It may be necessary to dry the barbecue and the inside of the cover. Any rust that is found that does not come into contact with the food should be treated with a rust inhibitor and painted with barbecue paint or a heat resistant paint. Chrome plated warming racks and grills should be coated with cooking oil.

I1. Cooking Grill

Clean with hot soapy water. To remove any food residue, use a mild cream cleaner on a non-abrasive pad. Rinse well and dry thoroughly.

I2. Burner Maintenance

Your burner has been preset for optimal flame performance. You will normally see a blue flame, possibly with a small yellow tip when the burner is alight. If the flame pattern is significantly yellow, this could be a problem caused by grease from cooking blocking the burner or spiders or other insects in the burner venturi. This can result in the flow of the gas and air mixture being restricted or blocked which may result in a fire behind the control panel causing serious damage to your barbecue. **If this happens, the gas should be immediately turned off at the bottle.** Burners should be inspected and cleaned on a regular basis in addition to the following conditions:

1. Bringing the barbecue out of storage.
2. One or more of the burners do not ignite.
3. The burner flame pattern is significantly yellow.
4. The gas ignites behind the control panel.

To clean a burner, remove it from the barbecue by removing the 2 securing screws underneath the body of the barbecue. The outside of the burner can be cleaned with a wire brush.

Clean the portholes with a pipe cleaner or piece of wire. Take care not to enlarge the portholes.

Clean the insect screen on the end of the venturi tube with a bristle brush (i.e. an old toothbrush).

Clean the venturi tube with a pipe cleaner or piece of wire. You may need a torch to see into the venturi tube to make sure it is clear. Turn the

burner up on end and lightly tap against a piece of wood to dislodge any debris from inside.

Replace the burner into the barbecue. The burner venturi is a loose fit on the gas valve. It does not need to form a gas tight seal.

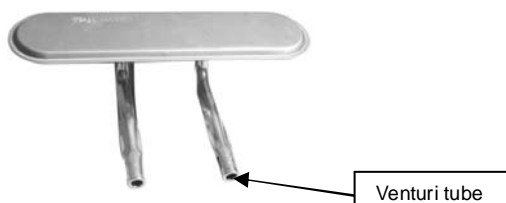

13. Lava Rock

It is not necessary to remove and wash the lava rock in order to keep it clean. Burning off the residue after each cooking should be sufficient. Heavily impregnated lava rock should be turned over so that the dirty side faces the burners in order to burn off any residue. Replacement lava rock is available from your local Outback® stockist.

14. Barbecue Body

Regularly remove excess grease or fat from the barbecue body with a soft plastic or wooden scraper. It is not necessary to remove all the grease from the body. If you need to clean fully, use hot soapy water and a cloth, or nylon-bristled brush only. Remove cooking surfaces and burners before full cleaning. Do not immerse the gas controls or manifold in water. Check burner operation after carefully refitting into body.

15. Barbecue Hood

Clean the hood with warm soapy water. Do not use solvents or abrasives which could damage the finish. The inside of the hood will also need cleaning to prevent an excessive build up of grease which can then turn to carbon and start to flake off and can resemble paint flaking off.

16. LPG Hose

The LPG hose does not have a time-limited in-service life but it is essential that the hose and end connections are regularly inspected and replaced if showing signs of:

- Physical damage such as – cuts or abrasion, cracking, stretching, flattening or kinking;
- Environmental deterioration such as – stiffening, cracking, de-lamination of outer covering, chemical degradation i.e. softening of outer coating by contact with oil;
- Hose service failure such as – blistering, soft spots, rupture or corrosion or loosening of the swaged fittings or worm drive clips attaching the hose.

17. Fixings

All screws and bolts, etc. should be checked and tightened on a regular basis.

18. Storage

Store your barbecue in a cool dry place. It must be inspected on a regular basis as damp or condensation can form which may result in damage to the barbecue. It may be necessary to dry the barbecue and the inside of the cover if used. Mould can grow under these conditions and should be cleaned and treated if required. Any rust that is found that does not come into contact with the food should be treated with a rust inhibitor and painted with barbecue paint or a heat resistant paint.. Chrome plated warming racks and grills should be coated with cooking oil. Wrap the burners in aluminium foil to help prevent insects or other debris from obstructing the burners.

The gas bottle must be always be disconnected from the barbecue and stored in a well ventilated area at least 1 metre away from any fixed ignition source. Do not store inside residential accommodation. Never store cylinders below ground level (e.g. cellars). Do not let children tamper with bottles.

J. Technical Specifications

	CE Approval	Heat Input	Burners	Injector Size	Gas / Pressure
Outback® Omega 150	0359 359BL239	6.2kW	1	0.89mm	Butane/28 -30mbar
Outback® Omega 250	0359 359BL239	6.2kW	1		
Side Burner	0359 359BL239	2.3kW	1	0.74mm	Propane/ 37mbar
Gas Consumption: Omega 150: 446g/hr Omega 250: 446g/hr Side Burner: 165g/hr					
Countries of Use: <small>l₃+ (28-30/37)</small> BE, CY, CZ, EE, FR, GR, IE, IT, LV, LT, LU, PT, SK, ES, CH, GB, RO <small>l₃B/P(30)</small> BG, CY, CZ, DK, EE, FI, GR, HR, LV, LT, LU, MT, NL, NO, SK, SI, SE, TR, IS <small>l₃B/P(50)</small> AT, DE, HU, SK, CH <small>l₃B/P(37)</small> PL					

Specifications are subject to change without prior notice.

K. Troubleshooting

Problem	Possible Cause	Solution
Burner will not light using the ignition system	LP gas cylinder is empty	Replace with full cylinder
	Faulty regulator	Have regulator checked or replace
	Obstructions in burner	Clean burner
	Obstructions in gas jets or gas hose	Clean jets and gas hose
	Electrode wire is loose or disconnected on electrode or ignition unit.	Reconnect wire
	Electrode or wire is damaged	Change electrode and wire
	Faulty pushbutton ignitor	Change ignitor
Burner will not light with a match	LP gas cylinder is empty	Replace with full cylinder
	Faulty regulator	Have regulator checked or replace
	Obstructions in burner	Clean burner
	Obstructions in gas jets or gas hose	Clean jets and gas hose
Low flame or flashback (fire in burner tube— a hissing or roaring noise may be heard)	LP gas cylinder too small	Use larger cylinder.
	Obstructions in burner	Clean burner
	Obstructions in gas jets or gas hose	Clean jets and gas hose
	Windy conditions.	Use BBQ in a more sheltered position
Gas valve knob difficult to turn	Gas valve jammed	Replace gas valve

For reference and correspondence, record your serial number here.
(See sticker on side of barbecue body.)

Serial No. _____
This number may be required when ordering spare parts or accessories. A part reference number may also be required where applicable.

OUTBACK UK LTD WARRANTY

OUTBACK barbecues are warranted to the original purchaser against defects in materials and workmanship for a period of one (1) year from the date of purchase. OUTBACK UK will, within this period, supply replacements for defective parts free of charge provided that:

- ◆ The product has not been used for trade, professional or hire purposes.
- ◆ The product has not been subjected to misuse or neglect, including fat fires and flare ups or use of a faulty or incorrect regulator.
- ◆ The product has not sustained damage through foreign objects, substances or accidents.
- ◆ The care and maintenance instructions given in your Outback manual have been followed.

This warranty is offered as an extra benefit and is in addition to the customers' statutory rights.

Outback UK does not warranty in any way the gas cylinder.

If you have any queries regarding the assembly or use of your barbecue please contact Outback UK

In the unlikely event that you experience problems with this barbeque, please contact:

Customer Service
Outback UK
Unit 2 Farleigh Hill
Tovil
Maidstone
Kent ME15 6RG

Tel: 01622 671771

Fax: 01622 673101

e-mail: customerservice@outbackuk.com

website: www.outbackuk.com

Published October 2008